



# BLOQUE P20M

---

Ficha Técnica



Media unidad del bloque P20.  
Utilizada para ajustes, terminaciones y  
encuentros. Favorece una modulación  
precisa sin cortes manuales.

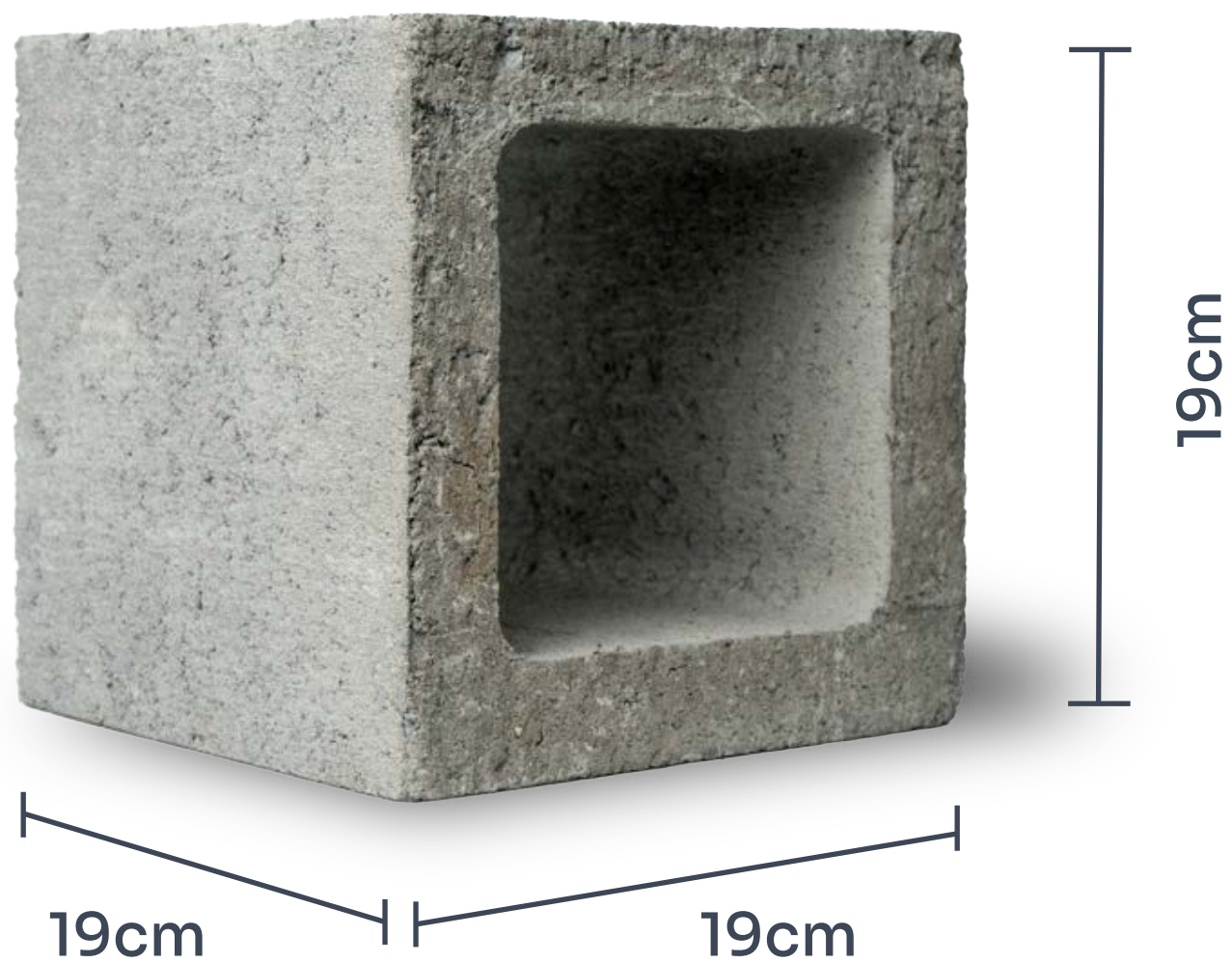

## Especificaciones

**DIMENSIÓN (CM):**  
19 x 19 x 19cm

**CANTIDAD/PALLET:** 216

**PESO PALLET (KG):** 1550,6

¿Cuántos bloques  
entran por m<sup>2</sup>?

**25**

# Ficha Técnica | Bloque P20M

5 Niveles - 180 Unidades

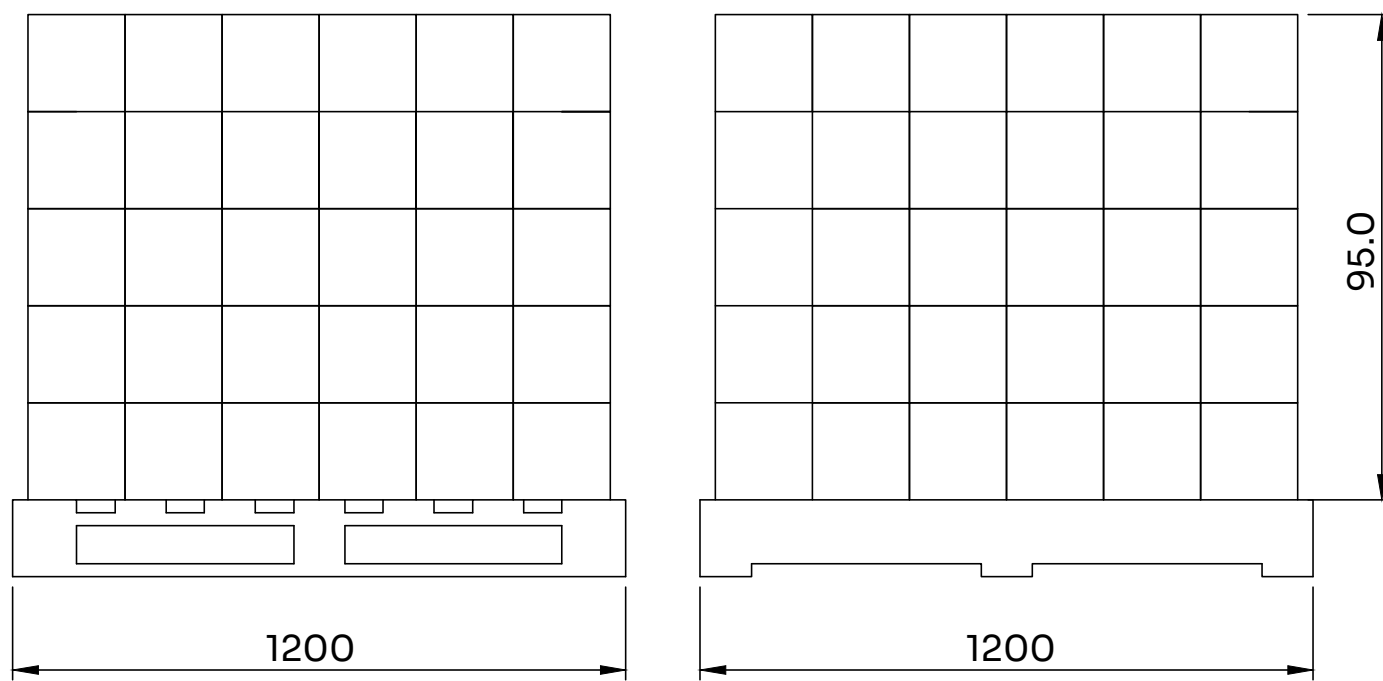

← Sentido de Presa

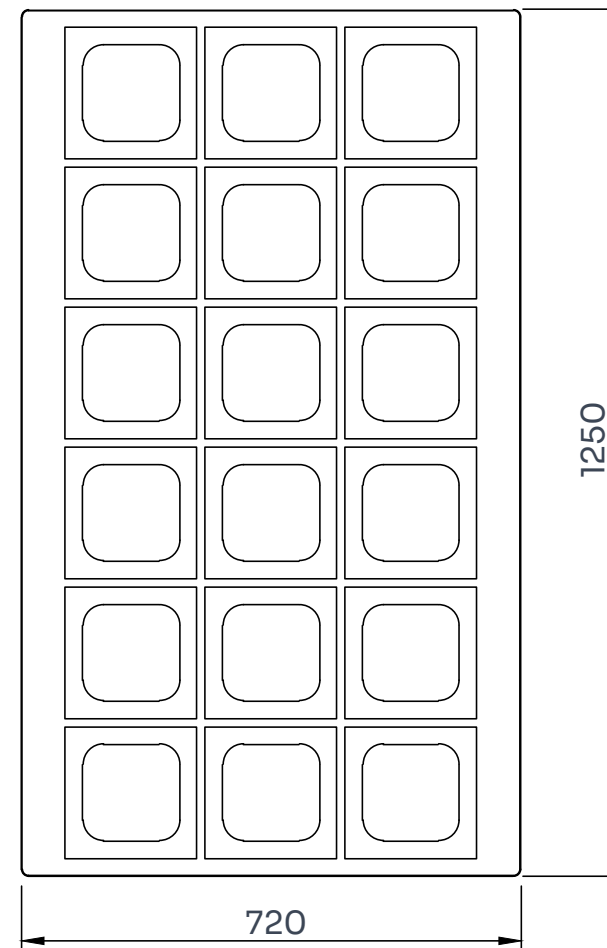

CORTE A-A

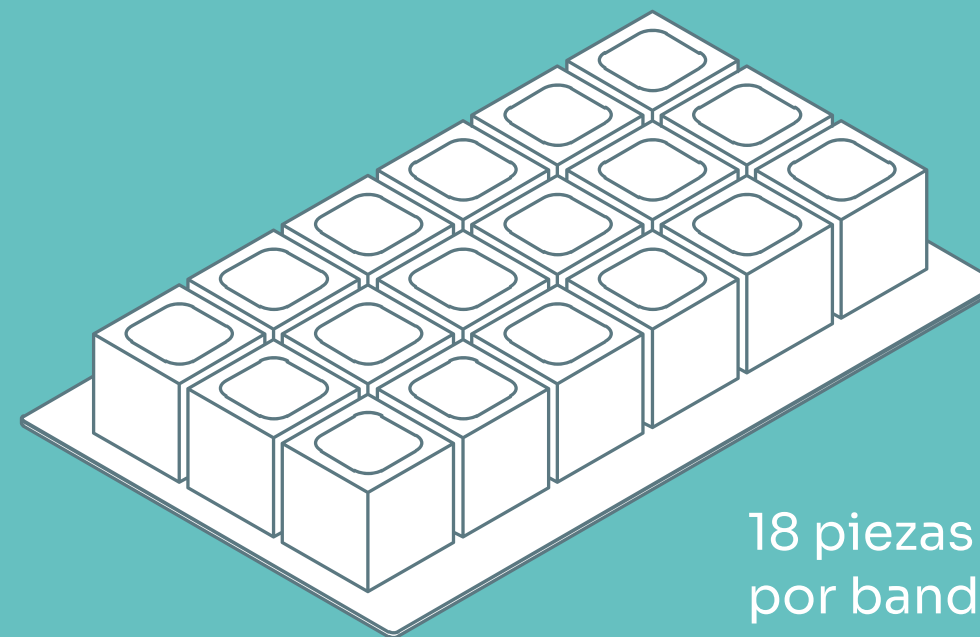
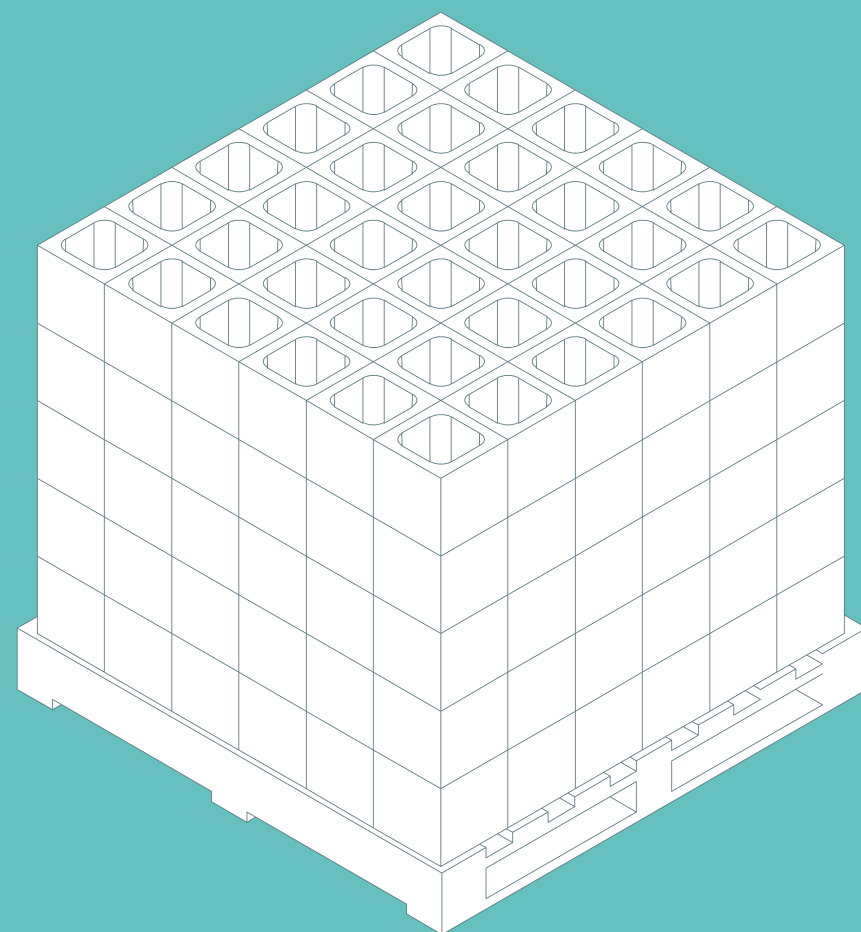
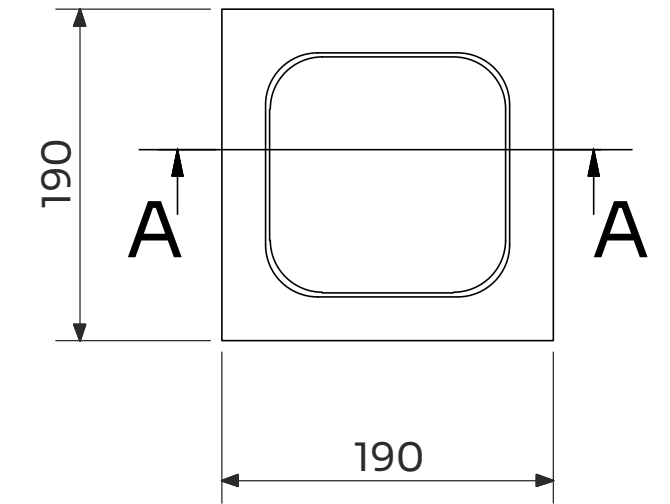
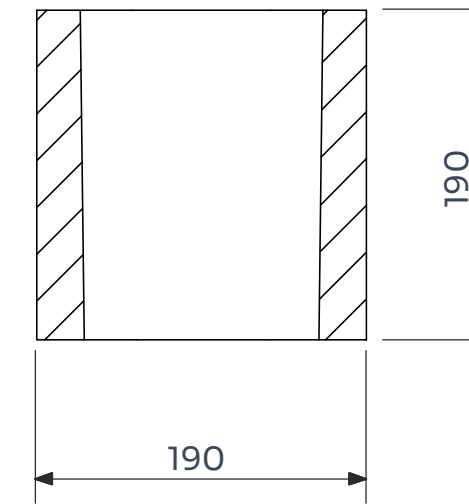

18 piezas  
por bandeja



Bloque  
190x190x190

# Ficha Técnica | Bloque P20M

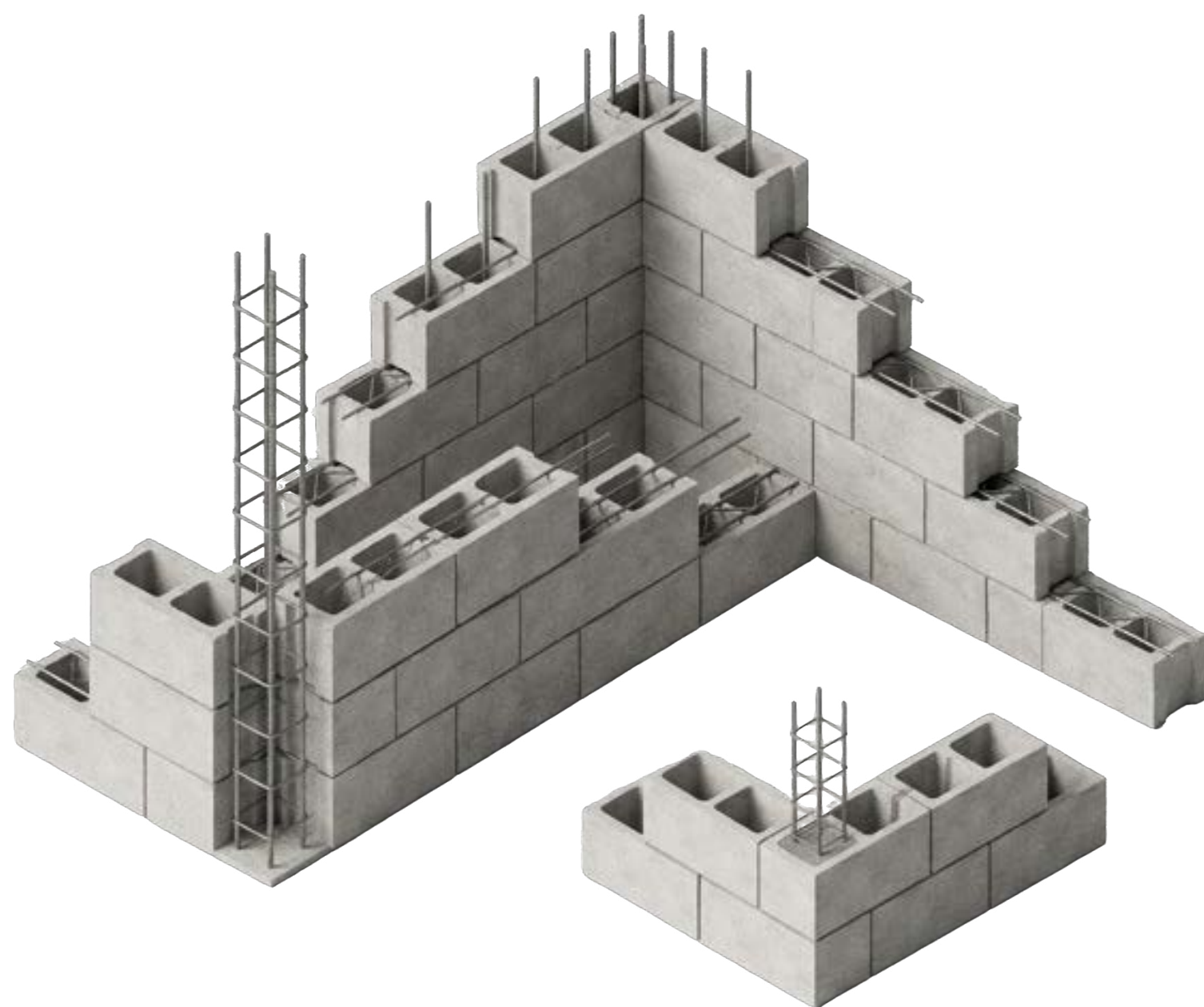

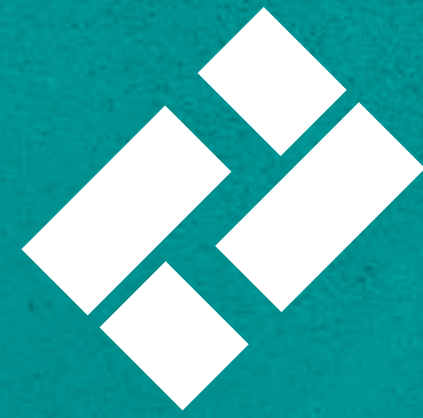

**BLOCKPRO**  
PREMOLDEADOS DE CALIDAD



[www.blockpro.com.ar](http://www.blockpro.com.ar)

 388 350-8777

